



CONTENITORI | BOXES ◀

EUROBOX ◀

ARMADI | CABINETS ◀

MULTISISTEM ◀

TOOLBOX ◀

PRODUZIONE DI COMPONENTI
IN PLASTICA E METALLO
PER IL MAGAZZINAGGIO



PRODUZIONE DI COMPONENTI IN PLASTICA E METALLO PER IL MAGAZZINAGGIO



Steel Plastic s.r.l. opera nel settore della classificazione ed ottimizzazione dello spazio per lo stoccaggio migliorando l'utilizzazione dei tempi necessari alla sistemazione di quanto serve. L'azienda propone contenitori, cassettiere, organizer e portautensili realizzati in resine termoplastiche riciclabili, oltre ad una gamma di armadi, carrelli ed accessori in metallo. I prodotti sono robusti, ergonomici, funzionali e realizzati nel rispetto dell'ambiente e della sicurezza personale.

Steel Plastic, utilizzando tecnologie avanzate, ricerca le migliori soluzioni che permettano di soddisfare, realizzare e fornire al cliente, strumenti ottimali con il miglior rapporto qualità-prezzo.

Questo know-how consente di realizzare valide soluzioni per lo stoccaggio, l'organizzazione dello spazio e miglior utilizzo del tempo.

Il nostro patrimonio è la soddisfazione dei nostri clienti.



Steel Plastic s.r.l. produces instruments for the space optimization and time saving.

The company produces recyclable thermoplastic storage bins, organizer, cabinets and tool boxes.

The product range also includes metal organizer trolleys and accessories.

Strong, ergonomic and user-friendly products that comply with the environmental and safety norms.

Thanks to the technology, Steel Plastic searches for the best solutions that meet the customers needs and give them the best price-quality ratio.

This know-how allows valid storage, space organisation and time-optimised solutions.

We supply effective and efficient products and equipment.

Our riches is the customer satisfaction.



Feel the difference!



CONTENITORI / boxes

6 KEY BOX

10 PANEL BOX

14 CARRY BOX

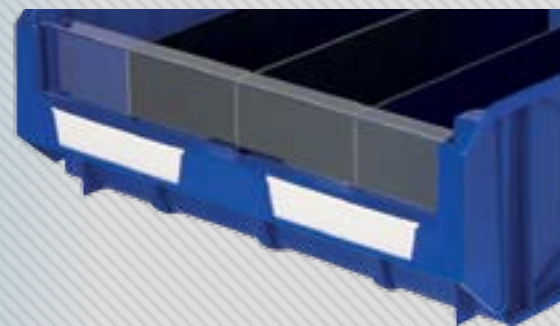

EURO BOX

18 EURO BOX



ARMADI / cabinets

25 STEEL BOX



MULTISISTEM

32 MULTIBOX

35 STAND

40 SLIDE

46 TROLLEY



TOOLBOX

48 TOOL BOX

53 CASES





CATALOGO PRODOTTI

Le misure indicate hanno una tolleranza di ± 2 mm.

I colori riprodotti hanno valore indicativo.

E' possibile fornire per quantità e prezzi da stabilire:

- Prodotti in colori fuori catalogo.
- Prodotti in materiale autoestinguente a norma UL 94.
- Prodotti personalizzati.

N.B.: I colori ed i modelli potrebbero subire variazioni senza preavviso.

Per impieghi diversi da quelli tradizionali, si suggerisce di chiedere esplicite indicazioni.



PRODUCTS CATALOGUE

All dimensions have a tolerance of ± 2 mm.

The reproduced colours have indicative value.

It's possible to supply the following in individually arranged quantities and prices:

- Goods in colours not in catalogue.
- Goods in self extinguishing materials conforming to the UL 04 norm.
- Personalized products.

N.B.: Colours and models can be subject to change without preadvice.

For specific applications, different from those indicated in this catalogue, please contact the company directly.

MAPPA COLORI / COLOR MAP



GI = Giallo / Yellow
RO = Rosso / Red
VE = Verde / Green
BL = Blu / Blue
GR = Grigio / Grey



RO = Rosso / Red
BI = Bianco / White
BL = Blu / Blue
GR = Grigio / Grey
VE = Verde / Green



Prodotti in materiale termoplastico riciclabile.
Products in recyclable raw materials



KEY BOX

6



Contenitori sovrapponibili prodotti in materiale termoplastico resistente ad acidi, olii e solventi e a temperature da -40° a +80°.
Fermi anteriori e fondo piatto per utilizzo su piani inclinati.
Pareti interne lisce per una facile pulizia.

I contenitori KEYBOX sono dotati di aggancio posteriore per l'impiego pensile su pannelli e carrelli.



Stackable boxes made of acid, oil, and solvent-proof thermoplastic material, for use from -40° to +80°C.
With frontal stop and flat bottom for inclined planes.
Smooth inner walls for easier cleaning.

The KEY BOX line products has a rear hooking for hanging use on panels and trolleys.

PANEL BOX

10



Pannelli pensili per contenitori della linea KEY BOX, realizzati in lamiera verniciata con resina epossidica nel colore grigio RAL 7035.



Hanging panels for the KEY BOX line, RAL 7035 epoxy resin-coated sheet.

CARRY BOX

14



Carrelli per contenitori della linea KEY BOX.
L'aspetto antinfortunistico di questi carrelli ha caratterizzato la loro progettazione.
Robusti e pratici, sono realizzati in lamiera elettrosaldata, verniciati con resina epossidica.
Dotati di 4 ruote gommate: 2 fisse, 1 piroettante e 1 piroettante con freno.
I carrelli della linea CARRY BOX vengono forniti smontati con schema di montaggio e viteria per l'assemblaggio.



Trolleys for KEY BOX holders.
Safety and accident prevention have been taken into account in designing these trolleys.
Strong and handy, epoxy resin-coated electrowelded sheet.
Four rubber wheels: 2 fixed, 1 pivoting and 1 pivoting with brake.
The CARRY BOX line trolleys are supplied disassembled, with the assembly schema and screws.



key box **K1**



Imballo Pz. Packages pcs.	50	
Dimensioni / Dimensions	H 53 mm - P 88 mm - L 105 mm	
Accessori / Accessories	Visiera trasparente a richiesta	Transparent peak on demande



key box **K2**

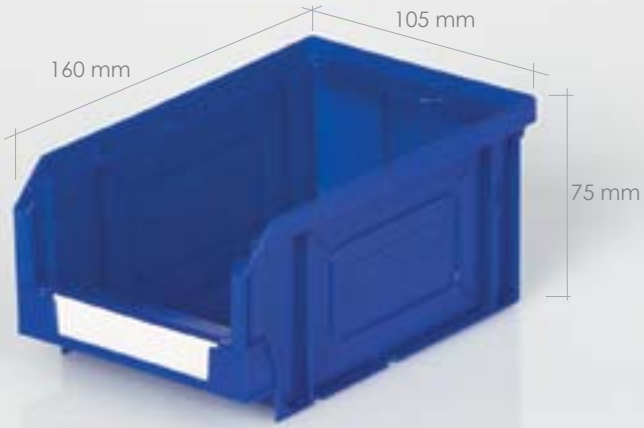

Imballo Pz. Packages pcs.	48	
Dimensioni / Dimensions	H 75 mm - P 160 mm - L 105 mm	
Accessori / Accessories	Visiera trasparente a richiesta	Transparent peak on demande

K3 key box



Imballo Pz. Packages pcs.	38	
Dimensioni / Dimensions	H 120 mm - P 235 mm - L 144 mm	
Accessori / Accessories	Visiera trasparente a richiesta	Transparent peak on demande

PRODUZIONE DI COMPONENTI IN PLASTICA E METALLO PER IL MAGAZZINAGGIO

K4 key box



Imballo Pz. Packages pcs.	24	
Dimensioni / Dimensions	H 163 mm - P 345 mm - L 205 mm	
Accessori / Accessories	Visiera trasparente e separatore mobile a richiesta	Transparent peak and mobile separator on demande



key box **K4/D**



Imballo Pz. / Packages pcs.	8	
Dimensioni / Dimensions	H 163 mm - P 345 mm - L 410 mm	
Accessori / Accessories	Visiera trasparente e separatori a richiesta	Transparent peak and separators on demand



key box **K5**



Imballo Pz. / Packages pcs.	12	
Dimensioni / Dimensions	H 189 mm - P 485 mm - L 298 mm	
Accessori / Accessories	Visiera trasparente e separatori a richiesta	Transparent peak and separator on demand

K6 key box

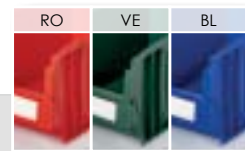

Imballo Pz. Packages pcs.	4	
Dimensioni / Dimensions	H 250 mm - P 600 mm - L 372 mm	
Accessori / Accessories	Visiera trasparente e separatore mobile a richiesta	Transparent peak and mobile separator on demande

PRODUZIONE DI COMPONENTI IN PLASTICA E METALLO PER IL MAGAZZINAGGIO

KEY BOX riciclati / recycled



La serie KEY BOX è disponibile in NERO realizzata con materiale riciclato
The whole series KEY BOX is available in BLACK color, made with recycled materials



K1



K2



K3



K4



K4/D



K5

panel box PB05

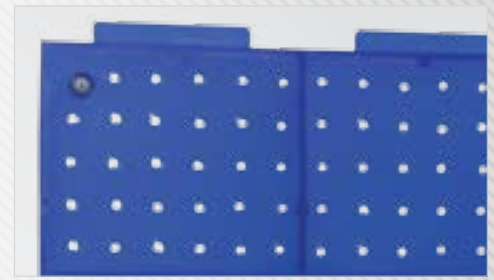
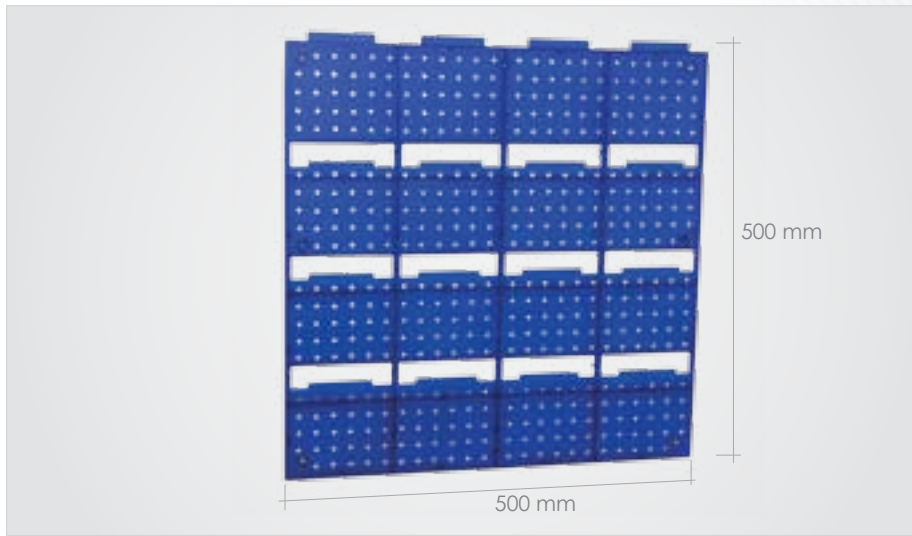

Pannelli modulari che si agganciano tra loro sia in verticale che in orizzontale in modo da creare una parete perfettamente lineare dove riporre ordinatamente tutti gli strumenti di lavoro. Forniti vuoti, con kit contenitori serie Key Boxes o ganci. Realizzato in Polipropilene.



Modular panels that fasten both vertically and horizontally by creating a linear wall where placing all working instruments. Supplied empty, with hooks or plastic bins Key Boxes. Made in polypropylene.

Imballo Pz. Packages pcs.	5	
Dimensioni / Dimensions	H 500 mm - L 500 mm	
Accessori / Accessories	Disponibile vuoto o con 4 allestimenti differenti	Available empty or with 4 different equipments.
Colore / Color	Blu	Blue



allestimenti / equipments PB05

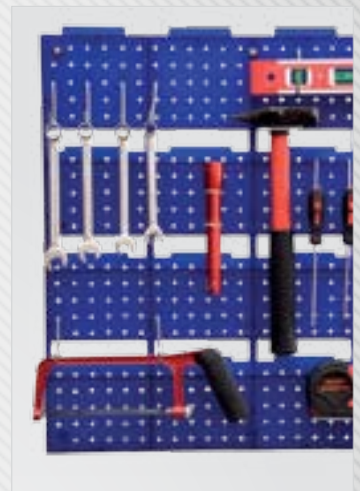
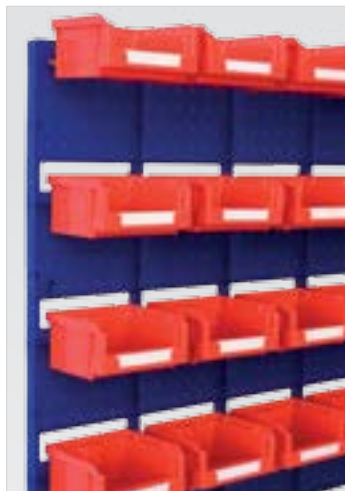

Allestimento / Equipment 1	
key box K1:	16
Imballo Pz. Packages pcs.	1

Allestimento / Equipment 2	
key box K2:	16
Imballo Pz. Packages pcs.	1

Allestimento / Equipment M	
key box K1:	8
key box K2:	8
Imballo Pz. Packages pcs.	1

Allestimento / Equipment H	
Con kit di ganci in metallo With metal hooks kit	
Imballo Pz. Packages pcs.	5

ATTREZZI NON INCLUSI / TOOLS NOT INCLUDED

PB45 panel box



Imballo Pz. Packages pcs.	2	
Dimensioni / Dimensions	H 450 mm - L 500 mm	
Accessori / Accessories	Disponibile vuoto o con kit KEY BOX	Available empty or with KEY BOX kit
Colore / Color	RAL 7035	

Kit KEY BOX a richiesta on demande KEY BOX kit	
Kit Standard	K1: n. 8 K2: n. 8

PRODUZIONE DI COMPONENTI IN PLASTICA E METALLO PER IL MAGAZZINAGGIO

PB90 panel box



Kit KEY BOX a richiesta on demande KEY BOX kit	
Kit Standard	K1: n. 12 K2: n. 16 K3: n. 3

Imballo Pz. Packages pcs.	2	
Dimensioni / Dimensions	H 900 mm - L 500 mm	
Accessori / Accessories	Disponibile vuoto o con kit KEY BOX	Available empty or with KEY BOX kit
Colore / Color	RAL 7035	

DESK Key

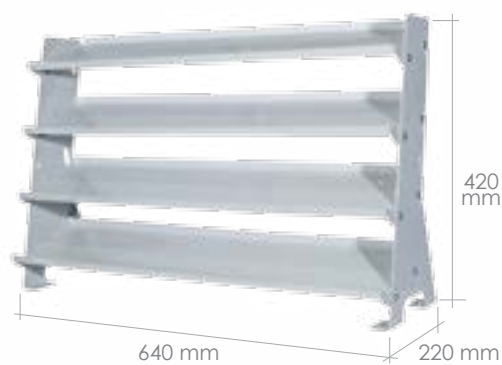

Inclinazione regolabile
Adjustable inclination

Imballo Pz. / Packages pcs.	1		
Dimensioni / Dimensions	H 420 mm - P 220 mm - L 640 mm		
Colore / Color	RAL 7035		
Fornito smontato / Supplied in kit form			
Dotazioni / Equipments			
	key box k2	key box k3	Tot*
Kit 1	24	-	24
Kit 2	12	4	16
Kit 3	-	12	12
<i>*Tot: Numero totale di contenitori / Total number of box</i>			

**STEEL
PLASTIC**

Allestimenti / Equipments



kit 1



kit 2



kit 3

BAR 97

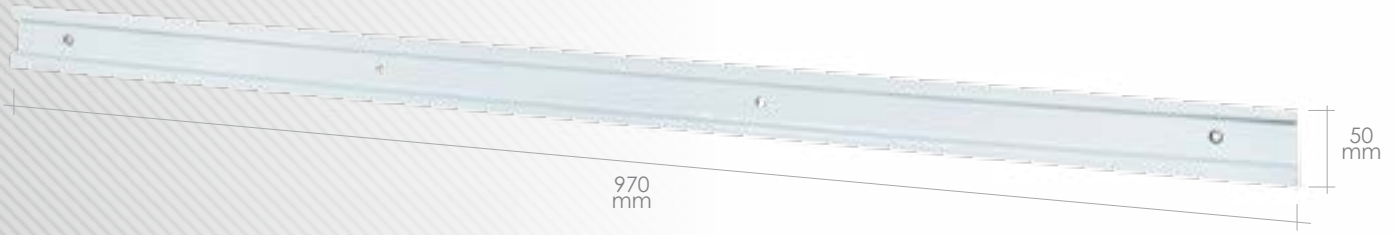

		
Imballo Pz. Packages pcs.	1	
Dimensioni Dimensions	H 50 mm - L 970 mm	
Colore / Color	RAL 7035	
Imballo a richiesta / Package on demande		

PRODUZIONE DI COMPONENTI IN PLASTICA E METALLO PER IL MAGAZZINAGGIO



*ogni cosa al suo posto e un posto per ogni cosa
everything in its place and a place for everything*

carry box **CB 100**



Imballo Pz. Packages pcs.	1	
Dimensioni Dimensions	H 1125 mm - P 605 mm - L 710 mm TOP: L 710 mm - P 400 mm	
Accessori Accessories	Disponibile vuoto o con kit KEY BOX	Available empty or with KEY BOX kit
Colore / Color	RAL 5010	
Kit KEY BOX a richiesta / on demande KEY BOX kit		
Kit Standard	K1: n. 12 K2: n. 48 K3: n. 16	

**STEEL
PLASTIC**

carry box **CB 120**





Spigoli smussati a 45°
45° Rounded edges

Imballo Pz. Packages pcs.	1	
Dimensioni Dimensions	H 1375 mm - P 605 mm - L 640 mm	
Accessori Accessories	Disponibile vuoto o con kit KEY BOX standard	Available empty or with KEY BOX kits
Colore / Color	RAL 7035	
Kit KEY BOX a richiesta / on demande KEY BOX kit		
Kit Standard	K1: n. 8 K2: n. 24 K3: n. 18	

CB 130 carry box



Spigoli smussati a 45°
45° Rounded edges

		
Imballo Pz. Packages pcs.	1	
Dimensioni Dimensions	H 1370 mm - P 605 mm - L 1000 mm	
Accessori Accessories	Disponibile vuoto o con kit KEY BOX	Available empty or with KEY BOX kit
Colore / Color	RAL 7035	
Kit KEY BOX a richiesta / on demande KEY BOX kit		
Kit Standard	K1: n. 16 K2: n. 48 K3: n. 36	





PRODUZIONE DI COMPONENTI IN PLASTICA E METALLO PER IL MAGAZZINAGGIO

CB 155 carry box



Spigoli smussati a 45°
45° Rounded edges

		
Imballo Pz. Packages pcs.	1	
Dimensioni Dimensions	H 1675 mm - P 605 mm - L 640 mm	
Accessori Accessories	Disponibile vuoto o con kit KEY BOX	Available empty or with KEY BOX kits
Colore / Color	RAL 7035	
Kit KEY BOX a richiesta / on demande KEY BOX kit		
Kit Standard	K1: n. 16 K2: n. 40 K3: n. 24	



carry box **CB 160**

CONTENITORI / boxes

EURO BOX



ARMADI / cabinets

MULTISISTEM

TOOLBOX



Spigoli smussati a 45°
45° Rounded edges

		
Imballo Pz. Packages pcs.	1	
Dimensioni Dimensions	H 1675 mm - P 605 mm - L 1000 mm	
Accessori Accessories	Disponibile vuoto o con con kit KEY BOX differenti	Available empty or with KEY BOX kit
Colore / Color	RAL 7035	
Kit KEY BOX a richiesta / on demande KEY BOX kit		
Kit Standard	K1: n. 32 K2: n. 80 K3: n. 48	



CB 100



CB 120



CB 130



CB 155



CB 160



EURO BOX

18



SERIE EURO - SERIE INDUSTRIALE

EUROCONTENITORI

Contenitori sovrapponibili in formato EURO. Realizzati in PEHD.

Struttura con telaio a ringhiera realizzata su una base in due misure standard;

Grazie all'elevata disponibilità di misure e modelli, questo prodotto è utilizzabile con profitto in svariati settori.

- Pareti robuste, rinforzate da diverse coste laterali per eccellenti proprietà meccaniche.
- Eccezionale indeformabilità.
- Resistente ai maggiori agenti chimici, oli e benzine;
- Residuenza termica: da -20° C a +80° C.
- Realizzati in materiale riciclabile.



EURO SERIES - INDUSTRIAL SERIES



STACKING CONTAINERS

Made in PEHD, the basic structure of the containers is a frame construction on the basis of two standard measurements.

Because of a multitude of sizes and versions this container type can be used in many different fields.

- Robust walls - strengthened by ribs - give excellent mechanical characteristics to the box for transport and stacking.
- Exceptional dimensional stability
- Resistant to nearly all acids and oils
- Excellent temperature stability (-20° to +80°C)
- Manufactured from recyclable material

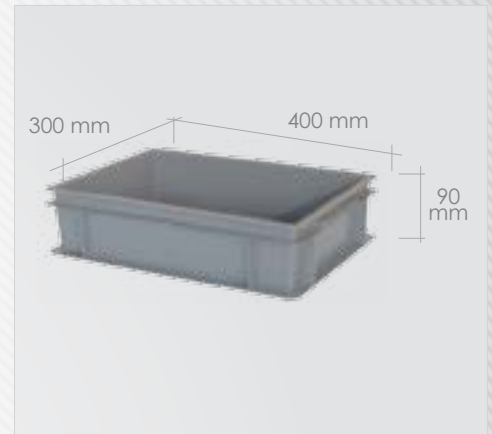

E 4309

		
Capienza / Capacity	7,5 lt.	
Dimensioni / Dimensions	H 90 mm - P 300 mm - L 400 mm	
Accessori / Accessories	Imballo a richiesta	Package on demande

**E 4312**

		
Capienza / Capacity	11 lt.	
Dimensioni / Dimensions	H 120 mm - P 300 mm - L 400 mm	
Accessori / Accessories	Imballo a richiesta	Package on demande

E 4317



		
Capienza / Capacity	16 lt.	
Dimensioni / Dimensions	H 170 mm - P 300 mm - L 400 mm	
Accessori / Accessories	Imballo a richiesta	Package on demande



SERIE EURO 400 x 300 mm

E 4322



		
Capienza / Capacity	21 lt.	
Dimensioni / Dimensions	H 220 mm - P 300 mm - L 400 mm	
Accessori / Accessories	Imballo a richiesta	Package on demande

E 4300

Coperchio per contenitori / Cover for box
E 4309 - E 4312 - E 4317 - E 4322





		
Capienza / Capacity	-	
Dimensioni / Dimensions	P 300 mm - L 400 mm	
Accessori / Accessories	Imballo a richiesta	Package on demande



600 x 400 mm **SERIE EURO**

E 6409

		
Capienza / Capacity	19 lt.	
Dimensioni / Dimensions	H 90 mm - P 400 mm - L 600 mm	
Accessori / Accessories	Imballo a richiesta	Package on demande

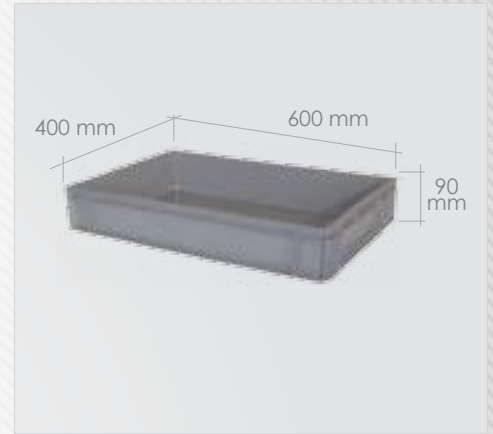

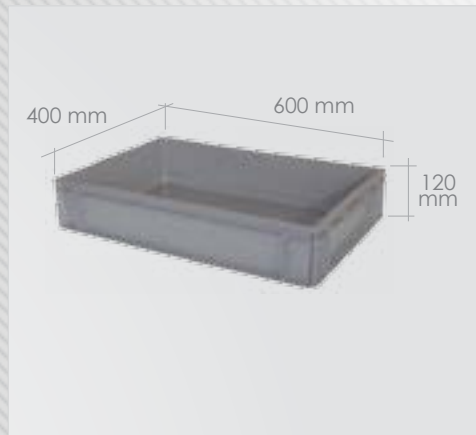

E 6412





		
Capienza / Capacity	23 lt.	
Dimensioni / Dimensions	H 120 mm - P 400 mm - L 600 mm	
Accessori / Accessories	Imballo a richiesta	Package on demande

E 6417

		
Capienza / Capacity	33 lt.	
Dimensioni / Dimensions	H 170 mm - P 400 mm - L 600 mm	
Accessori / Accessories	Imballo a richiesta	Package on demande



E 6420

		
Capienza / Capacity	40 lt.	
Dimensioni / Dimensions	H 200 mm - P 400 mm - L 600 mm	
Accessori / Accessories	Imballo a richiesta	Package on demand

SERIE EURO 600 x 400 mm

6432



Capienza / Capacity	63 lt.	
Dimensioni / Dimensions	H 320 mm - P 400 mm - L 600 mm	
Accessori / Accessories	Imballo a richiesta	Package on demande

E 6441

Capienza / Capacity	80 lt.	
Dimensioni / Dimensions	H 410 mm - P 400 mm - L 600 mm	
Accessori / Accessories	Imballo a richiesta	Package on demande



E 6400

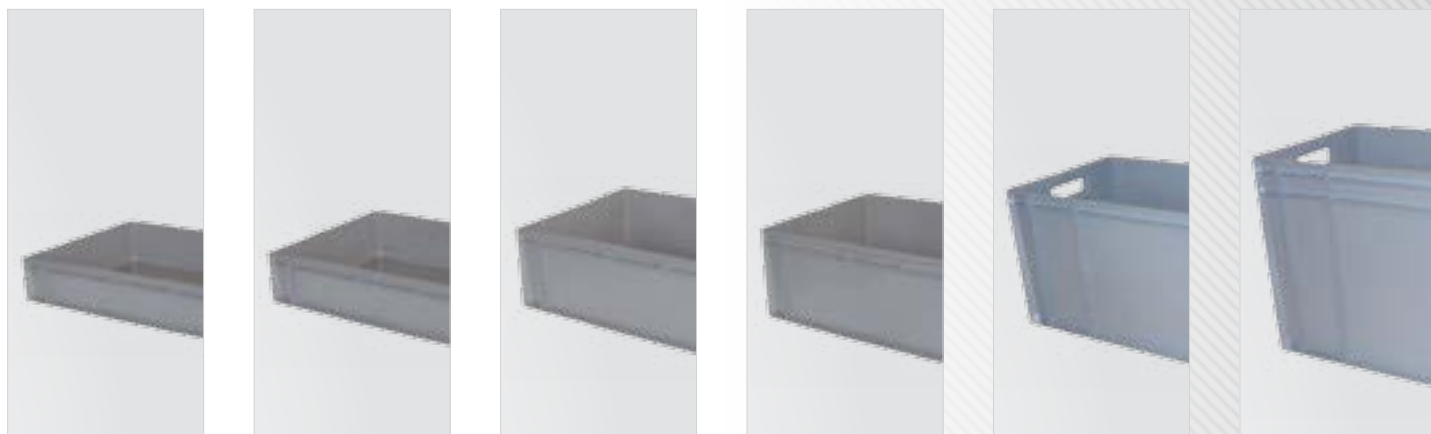

Coperchio per contenitori / Cover for box
E 6409 - E 6412 - E 6417 - E 6420 - E 6432 - E 6441

Capienza / Capacity	-	
Dimensioni / Dimensions	P 400 mm - L 600 mm	
Accessori / Accessories	Imballo a richiesta	Package on demand



SERIE INDUSTRIALE



1195

		
Capienza / Capacity	15 lt.	
Dimensioni / Dimensions	H 215 mm - P 295 mm - L 395 mm	
Accessori / Accessories	Imballo a richiesta	Package on demande





1196



		
Capienza / Capacity	15 lt.	
Dimensioni / Dimensions	H 215 mm - P 295 mm - L 395 mm	
Accessori / Accessories	Imballo a richiesta	Package on demande



1197

		
Capienza / Capacity	25 lt.	
Dimensioni / Dimensions	H 165 mm - P 395 mm - L 595 mm	
Accessori / Accessories	Imballo a richiesta	Package on demande



1198



		
Capienza / Capacity	35 lt.	
Dimensioni / Dimensions	H 215 mm - P 395 mm - L 595 mm	
Accessori / Accessories	Imballo a richiesta	Package on demand

CONTENITORI / boxes

EURO BOX

ARMADI / cabinets



MULTISISTEM

TOOLBOX

INDUSTRIAL SERIE

1199



		
Capienza / Capacity	55 lt.	
Dimensioni / Dimensions	H 320 mm - P 395 mm - L 595 mm	
Accessori / Accessories	Imballo a richiesta	Package on demande

1100

Coperchio per contenitori / Cover for box
1195 - 1196

		
Capienza / Capacity	-	
Dimensioni / Dimensions	P 295 mm - L 395 mm	
Accessori / Accessories	Imballo a richiesta	Package on demande



1200

Coperchio per contenitori / Cover for box
1197 - 1198 - 1199



		
Imballo / Package	-	
Dimensioni / Dimensions	P 395 mm - L 595 mm	
Accessori / Accessories	Imballo a richiesta	Package on demand



ARMADI

cabinets



STEELBOX

25



In lamiera. Interno zincato. Esterno film poliestere 35 µm.

Armadi costruiti in lamiera d'acciaio 10/10. L'assemblaggio per mezzo di viti, garantisce solidità strutturale e rigidità comparabile a quella degli armadi monoblocco.

La zincatura della lamiera assicura un'ottima resistenza all'ossidazione e alla corrosione; inoltre l'esclusivo rivestimento esterno costituito da film in poliestere co-laminato, dello spessore di 35 micron, permette la coloritura in grigio per le pareti esterne e nel colore blu per le porte.

Un ulteriore film protettivo di polietilene trasparente rimovibile protegge il prodotto.

Tutti gli armadi sono disponibili con o senza porte e sono dotati di **serratura con tre punti di chiusura** e 2 chiavi, ripiani in acciaio zincato posizionabili in altezza secondo le diverse esigenze con passo di 25 mm.

I ripiani per gli armadi con profondità 520 mm vengono ottenuti affiancando 2 ripiani da 260 mm, migliorando così la capacità di carico.

Gli armadi vengono forniti con 4 ripiani di serie e spediti smontati per ridurre i volumi nello stoccaggio e nel trasporto, diminuendo così costi e rischi di avarie.



Of steel sheet. Inside hot galvanized. Outside polyester film 35 µm.

The cabinets are made of steel sheet 10/10. The screws guarantee the same sturdiness and rigidity of the one-piece cabinets. The hot galvanisation process guarantees excellent resistance to oxidation and corrosion; the outer 35 micron thick co-laminated polyester film, gives the grey color to the outer walls and the blue color to the doors.



A removable transparent polyethylene film protects the product.

The cabinets can be supplied with or without doors and feature a **lock with three locking positions** and two keys; the height-adjustable galvanised steel shelves, 25 mm away from one other, can be placed according to the needs. The shelves for the 520 mm deep cabinets are obtained by placing two 260 mm shelves one next to the other, thus improving their load-bearing capacity.

The cabinets are supplied with 4 standard shelves and delivered disassembled, to optimise the storage volume, thus reducing the risks and freights.

AR 70/27 | AR 70/27-P steel box



		
Imballo Pz. Packages pcs.	1	
Dimensioni Dimensions	H 1950 mm - P 275 mm - L 700 mm	
Portata max. armadio Max. recommended load-bearing capacity of the cabinet.	250 Kg.	
Portata max. ripiano Max. recommended load-bearing capacity of the ledges	30 Kg.	

Gli armadi con profondità 275 mm devono essere fissati a muro con l'impiego di staffe fornite di serie.

The 275 mm deep cabinets must be anchored to the wall using the brackets included in the supply.

PRODUZIONE DI COMPONENTI IN PLASTICA E METALLO PER IL MAGAZZINAGGIO

Dotazione / Equipment

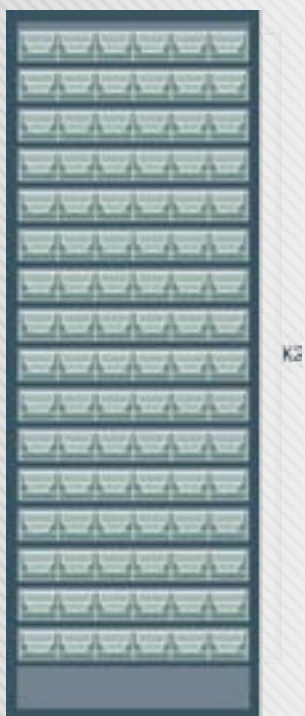

A key box K2: 96
Ripiani / ledges: 16





B key box K3: 36
Ripiani / ledges: 10



C key box K2: 48
key box K3: 28
Ripiani / ledges: 14

steel box AR 70/52 | AR 70/52-P

		
Imballo Pz. Packages pcs.	1	
Dimensioni Dimensions	H 1950 mm - P 520 mm - L 700 mm	
Portata max. armadio Max. recommended load-bearing capacity of the cabinet.	300 Kg.	
Portata max. ripiano Max. recommended load-bearing capacity of the ledges	40 Kg.	



Dotazione / Equipment



A

- key box K2: 36
- key box K3: 12
- key box K4: 9
- key box K5: 2
- Ripiani / ledges: 16



B

- key box K4: 24
- Ripiani / ledges: 16



C

- key box K4: 9
- key box K5: 10
- Ripiani / ledges: 14

AR 100/27 | AR 100/27-P steel box



Imballo Pz. Packages pcs.	1	
Dimensioni Dimensions	H 1950 mm - P 275 mm - L 1050 mm	
Portata max. armadio Max. recommended load-bearing capacity of the cabinet.	300 Kg.	
Portata max. ripiano Max. recommended load-bearing capacity of the ledges	40 Kg.	

Gli armadi con profondità 275 mm devono essere fissati a muro con l'impiego di staffe fornite di serie.

The 275 mm deep cabinets must be anchored to the wall using the brackets included in the supply.

PRODUZIONE DI COMPONENTI IN PLASTICA E METALLO PER IL MAGAZZINAGGIO

Dotazione / Equipments



A key box K2: 144
Ripiani / ledges: 16

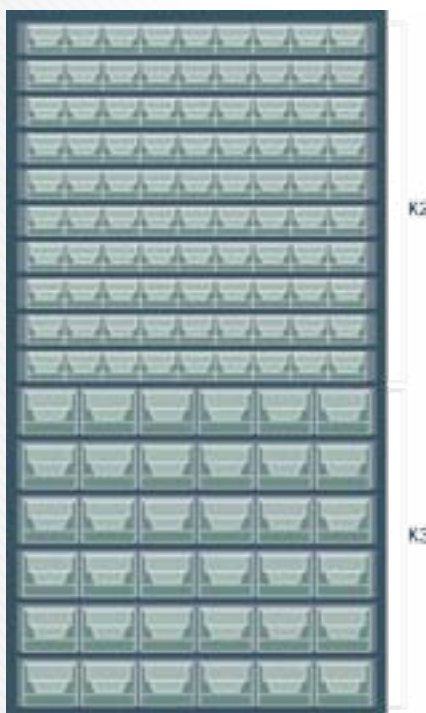

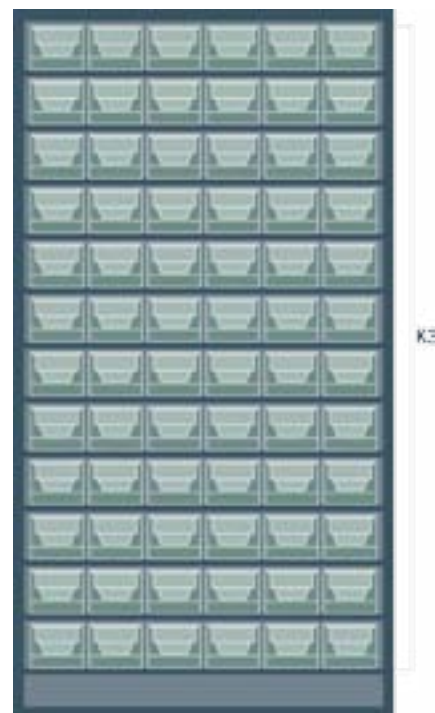

B key box K2: 90
key box K3: 36
Ripiani / ledges: 15



C key box K3: 72
Ripiani / ledges: 12

steel box AR 100/52 | AR 100/52-P

		
Imballo Pz. Packages pcs.	1	
Dimensioni Dimensions	H 1950 mm - P 520 mm - L 1050 mm	
Portata max. armadio Max. recommended load-bearing capacity of the cabinet.	500 Kg.	
Portata max. ripiano Max. recommended load-bearing capacity of the ledges	40 Kg.	



Dotazione / Equipment



A

- key box K2: 27
- key box K3: 18
- key box K4: 12
- key box K5: 6
- Ripiani / ledges: 15



B

- key box K4: 16
- key box K4/D: 8
- Ripiani / ledges: 16



C

- key box K5: 24
- Ripiani / ledges: 14



ALFA

PANNELLI FONDO / Fund panels

Imballo da pz. / Package of pcs. : 2



BETA

PANNELLI PORTE / Door panels

Imballo da pz. / Package of pcs. : 2

PRODUZIONE DI COMPONENTI IN PLASTICA E METALLO PER IL MAGAZZINAGGIO



GAMMA

RIPIANI / Ledges

Imballo da pz. / Package of pcs. : 2



JOLLY

PANNELLI / Panels

Imballo da pz. / Package of pcs. : 2

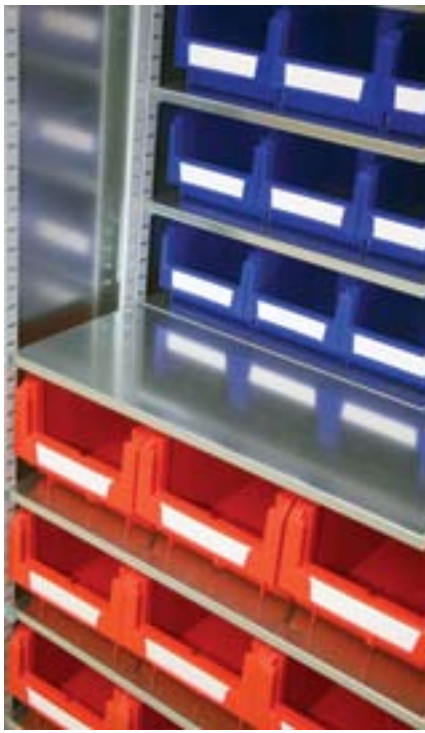



MULTI BOX

32



Cassettiere componibili realizzate in resina termoplastica resistente agli urti, dotate di cassetti estraibili basculanti con maniglia ergonomica di forma arrotondata e porta etichette di grandi dimensioni integrato nel cassetto. Grazie alle guide presenti sulla parte posteriore dell'involucro portacassetti, tutte le cassette MULTIBOX possono essere utilizzate anche a muro per mezzo di viti e su numerosi supporti metallici al fine di realizzare pareti attrezzate di diverse dimensioni. Le cassette sono disponibili in 5 differenti dimensioni.



Modular drawer storage cabinets made of shockproof thermoplastic resin, with tilting pull-open drawers, rounded ergonomic handle and large label holder. Thanks to the guides on the back of the drawer-holding casing, all the MULTIBOX drawer storage cabinets can also be wall-mounted by means of screws and metal supports to create modular equipped walls. The drawer storage cabinets are available in five different sizes.

STAND

35



Espositori da banco, da parete e con base di appoggio a terra, realizzati in lamiera elettrosaldata e verniciati a forno con polvere epossidica di colore grigio RAL 7035. Disponibili con kit standard di cassettiere MULTIBOX.



Bench, wall-mount and self-standing display frames, made of RAL 7035 grey epoxy powder-painted electro-welded sheet. Available with the standard kit of the MULTIBOX drawer storage cabinets.

SLIDE

40



Armadi costruiti in lamiera elettrosaldata con barre di rinforzo e corredato di pannelli scorrevoli su cuscinetti a sfera, verniciato a forno con polvere epossidica di colore Grigio RAL 7035. Questo armadio è progettato in maniera tale da rendere agevole e veloce l'assemblaggio direttamente nel luogo di utilizzo. I carrelli vengono forniti smontati con schema di montaggio e viteria di assemblaggio.



Cabinets made of electro-welded sheet and reinforcement bars, feature panels sliding on roller bearings; RAL 7035 Grey epoxy powder-painted. The cabinet has been designed in a way that facilitates the assembly on site. The product is supplied disassembled, with the assembly schema and screws.

TROLLEY

46



Carrelli per contenitori della linea MULTIBOX. L'aspetto antinfortunistico di questi carrelli ha caratterizzato la loro progettazione. Robusti e pratici, sono realizzati in lamiera elettrosaldata, verniciati con resina epossidica. Dotati di 4 ruote gommate: 2 fisse, 1 piroettante e 1 piroettante con freno. I carrelli della linea CARRY BOX vengono forniti smontati con schema di montaggio e viteria per l'assemblaggio.



Trolley for MULTIBOX holders. Safety and accident prevention have been taken into account in designing these trolley. Strong and handy, epoxy resin-coated electro-welded sheet. Four rubber wheels: 2 fixed, 1 pivoting and 1 pivoting with brake. The CARRY BOX line trolley are supplied disassembled, with the assembly schema and screws for assembly.



multi box MB 9



Imballo Pz. / Packages pcs.	1	
Dimensioni / Dimensions	H 76 mm - P 68 mm - L 600 mm	
Accessori / Accessories	Fermo per cassetti	Locking bar for drawers



multi box MB 6



Imballo Pz. / Packages pcs.	1	
Dimensioni / Dimensions	H 112 mm - P 94 mm - L 600 mm	
Accessori / Accessories	Fermo per cassetti	Locking bar for drawers

MB 5 multi box



Imballo Pz. Packages pcs.	1	
Dimensioni / Dimensions	H 164 mm - P 135 mm - L 600 mm	
Accessori / Accessories	Fermo per cassetti e separatore mobile a richiesta	Locking bar for drawers and mobile separator on demande

PRODUZIONE DI COMPONENTI IN PLASTICA E METALLO PER IL MAGAZZINAGGIO

MB 4 multi box



Imballo Pz. Packages pcs.	1	
Dimensioni / Dimensions	H 206 mm - P 177 mm - L 600 mm	
Accessori / Accessories	Visiera trasparente e separatore a richiesta	Transparent peak and mobile separator on demande



multi box MB 3



Imballo Pz. Packages pcs.	1	
Dimensioni / Dimensions	H 240 mm - P 214 mm - L 600 mm	
Accessori / Accessories	Fermo per cassetti e separatore mobile a richiesta	Locking bar for drawers and mobile separator on demande



SB STAND BAG stand

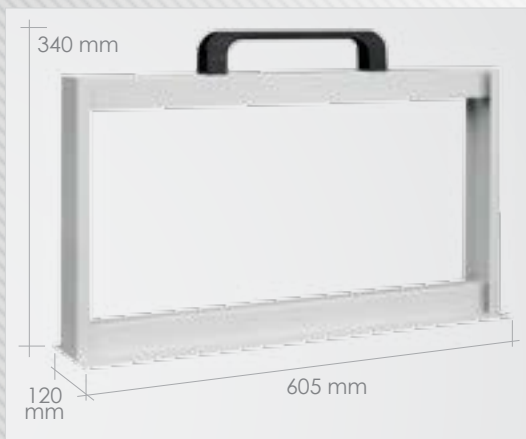

Imballo Pz. Packages pcs.	1	
Dimensioni Dimensions	H 340 mm - P 120 mm - L 605 mm	
Disponibile vuota o con kit standard / Available empty or with standard kit		
Standard kit MB 6	MB 6: 6 MB 6 fermi/locking bar: 6	

PRODUZIONE DI COMPONENTI IN PLASTICA E METALLO PER IL MAGAZZINAGGIO

S 500 stand



Imballo Pz. Packages pcs.	1	
Dimensioni Dimensions	H 500 mm - P 150 mm - L 605 mm	
Colore / Color	RAL 7035	
Disponibile con e senza kit MULTIBOX / Available with or without MULTIBOX kit		
MULTIBOX kit	MB 9: 1 MB 6: 1 MB 5: 1 MB 4: 1	

stand S 510

		
Telaio da muro / Wallframe		
Imballo Pz. Packages pcs.	1	
Dimensioni Dimensions	H 1000 mm - P 40 mm - L 605 mm	
Colore / Color	RAL 7035	
Disponibile con o senza kit MULTIBOX / Available with or without MULTIBOX kit		

Dotazione / Equipment:

- MB 9: 2
- MB 6: 1
- MB 5: 2
- MB 4: 1
- MB 3: 1

Totale numero cassetti / Total number of drawers:
41

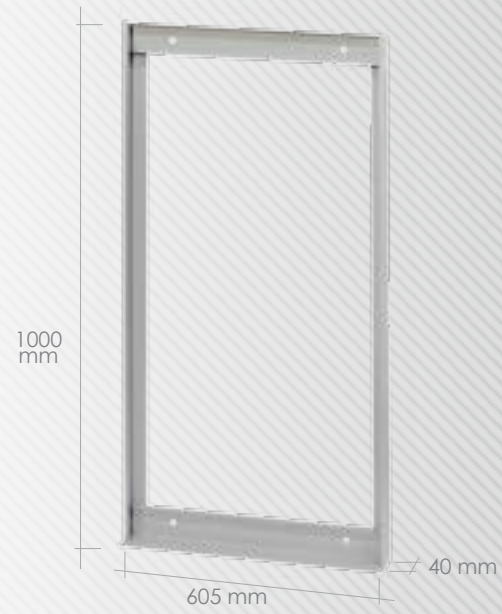

stand S 514

		
Telaio con base / Frame with base		
Imballo Pz. Packages pcs.	1	
Dimensioni Dimensions	H 1400 mm - P 300 mm - L 605 mm	
Colore / Color	RAL 7035	
Disponibile con o senza kit MULTIBOX / Available with or without MULTIBOX kit		

Dotazione / Equipment:



- MB 9: 1
- MB 6: 3
- MB 5: 2
- MB 4: 2
- MB 3: 1

Totale numero cassetti / Total number of drawers:
48



S 516 stand



		
Telaio con base / Frame with base		
Imballo Pz. Packages pcs.	1	
Dimensioni Dimensions	H 1650 mm - P 300 mm - L 605 mm	
Colore / Color	RAL 7035	
Disponibile con o senza kit MULTIBOX / Available with or without MULTIBOX kit		

Dotazione / Equipment:

MB 9: 2
MB 6: 3
MB 5: 3
MB 4: 2
MB 3: 1



Totale numero cassetti / Total number of drawers:
62



PRODUZIONE DI COMPONENTI IN PLASTICA E METALLO PER IL MAGAZZINAGGIO

S 518 stand



		
Telaio con base / Frame with base		
Imballo Pz. Packages pcs.	1	
Dimensioni Dimensions	H 1850 mm - P 300 mm - L 605 mm	
Colore / Color	RAL 7035	
Disponibile con o senza kit MULTIBOX / Available with or without MULTIBOX kit		



Dotazione / Equipment:

MB 9: 2
MB 6: 3
MB 5: 3
MB 4: 2
MB 3: 2

Totale numero cassetti / Total number of drawers:
65



stand S 517

		
Telaio con base / Frame with base		
Imballo Pz. Packages pcs.	1	
Dimensioni Dimensions	H 1650 mm - P 480 mm - L 605 mm	
Colore / Color	RAL 7035	
Disponibile con o senza kit MULTIBOX / Available with or without MULTIBOX kit		

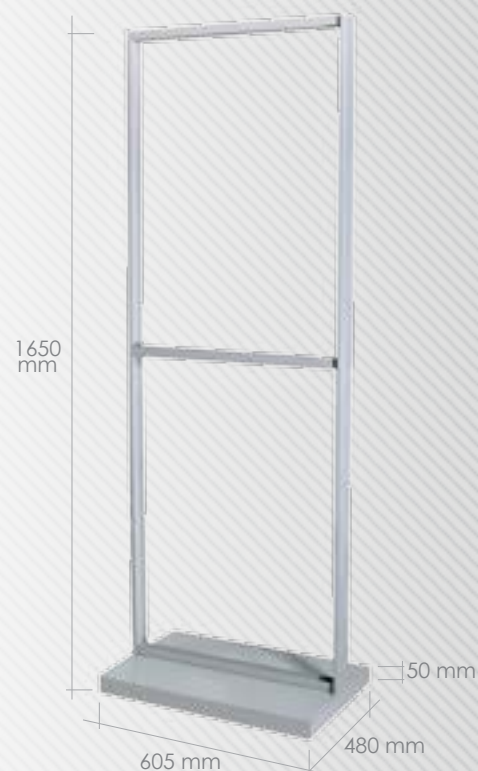



Dotazione / Equipment:

MB 9: 2
MB 6: 6
MB 5: 8
MB 4: 4
MB 3: 2

Totale numero cassetti / Total number of drawers:
116



stand S 519

		
Scaffale / Shelf		
Imballo Pz. Packages pcs.	1	
Dimensioni Dimensions	H 1030 mm - P 250 mm - L 665 mm	
Colore / Color	RAL 7035	
Venduto assemblato con kit MULTIBOX / Sold assembled with MULTIBOX kit		



Dotazione / Equipment:

MB 6: 2
MB 5: 2
MB 4: 2

Totale numero cassetti / Total number of drawers:
30

CONTENTORI / boxes

EURO BOX

ARMADI / cabinets

MULTISISTEM

TOOLBOX

S 520 stand



Scaffale / Shelf		
Imballo Pz. Packages pcs.	1	
Dimensioni Dimensions	H 2000 mm - P 250 mm - L 665 mm	
Colore / Color	RAL 7035	
Venduto assemblato con kit MULTIBOX / Sold assembled with MULTIBOX kit		

Dotazione / Equipment:

MB 6: 4
MB 5: 5
MB 4: 3

Totale numero cassetti / Total number of drawers:

61

PRODUZIONE DI COMPONENTI IN PLASTICA E METALLO PER IL MAGAZZINAGGIO

PROMO stand





Telaio con base / Frame with base		
Imballo Pz. Packages pcs.	1	
Dimensioni Dimensions	H 730 mm - P 200 mm - L 600 mm	
Colore / Color	RAL 7035	
Disponibile con o senza kit MULTIBOX / Available with or without MULTIBOX kit		
Possibilità di applicare il vostro logo / Possibility of applying your logo		

Dotazione / Equipment:

MB 9: 1 con fermo / with blocking bar
MB 6: 1 con fermo / with blocking bar
MB 5: 1 con fermo / with blocking bar
MB 4: 1 con fermo / with blocking bar

Totale numero cassetti / Total number of drawers: 24



					
Imballo Pz. Packages pcs.	1				
Dimensioni Dimensions	H 1950 mm - P 520 mm - L 700 mm				
Portata singolo pannello Capacity of each panel	150 Kg.				
Fornito smontato / Supplied disassembled					
Dotazioni / Equipments					
	Fondo/Fund	Panel 1	Panel 2	Panel 3	Tot*
STANDARD	MB 5: 22	MB 5: 11	-	-	206
A	MB 5: 2 MB 4: 16	MB 6: 16	-	-	170
B	MB 5: 2 MB 3: 14	MB 6: 16	-	-	148
*Tot: Numero totale di cassetti / Total number of drawers					

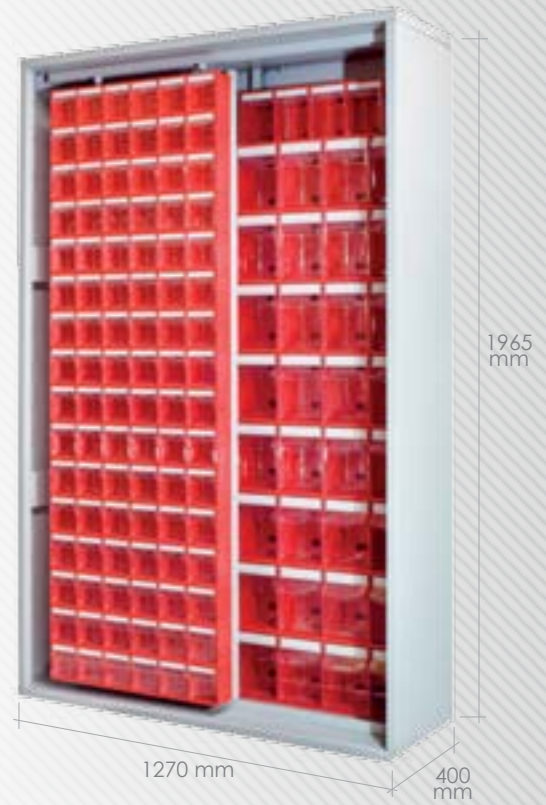

Standard

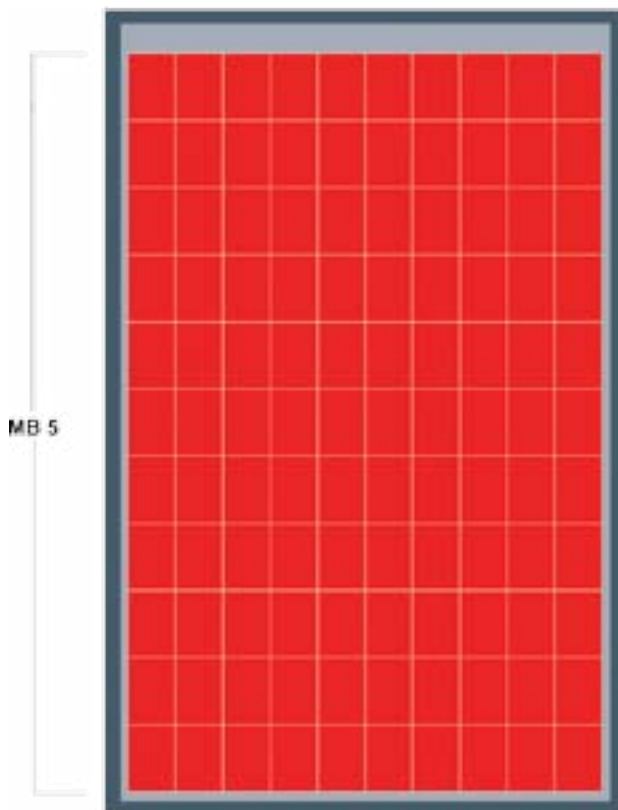

Fondo / Fund

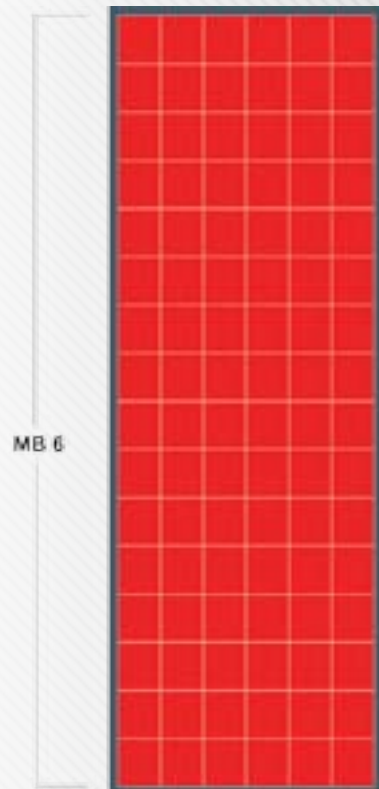

Pannelli / Panels

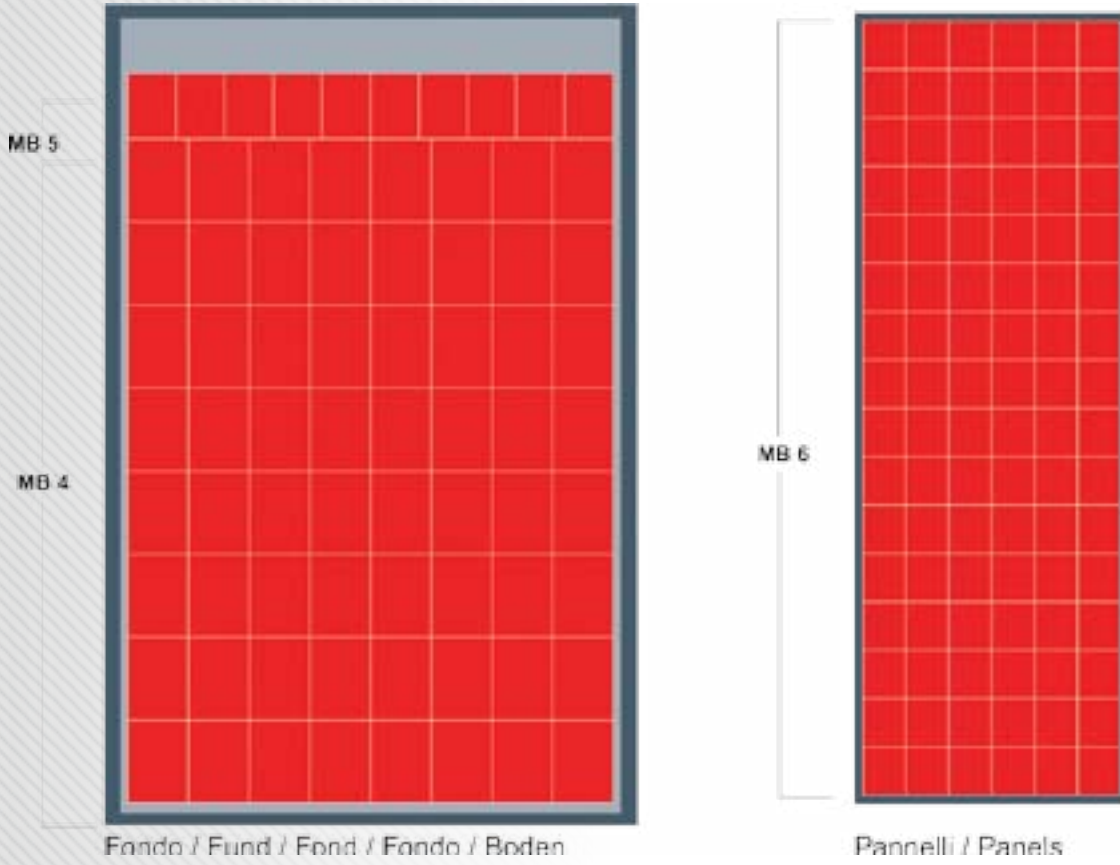

A

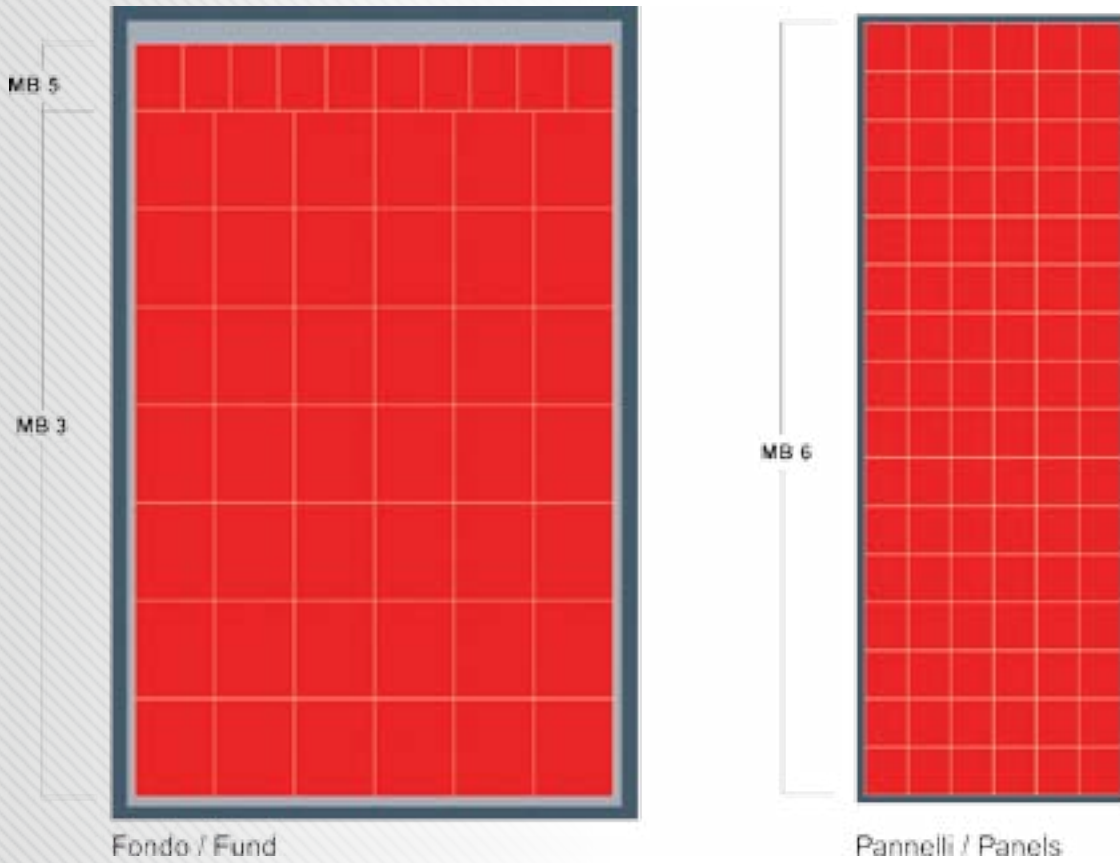

PRODUZIONE DI COMPONENTI IN PLASTICA E METALLO PER IL MAGAZZINAGGIO

B



					
Imballo Pz. Packages pcs.	1				
Dimensioni Dimensions	H 1965 mm - P 605 mm - L 1270 mm				
Portata singolo pannello Capacity of each panel	150 Kg.				
Fornito smontato / Supplied disassembled					
Dotazioni / Equipments					
	Fondo/Fund	Panel 1	Panel 2	Panel 3	Tot*
STANDARD	MB 4: 2	MB 4: 16	MB 6: 16	-	225
A	MB 5: 2 MB 3: 14	MB 5: 1 MB 4: 8	MB 6: 16	-	240
B	MB 5: 22	MB 6: 16	MB 6: 16	-	302
*Tot: Numero totale di cassetti / Total number of drawers					



Standard

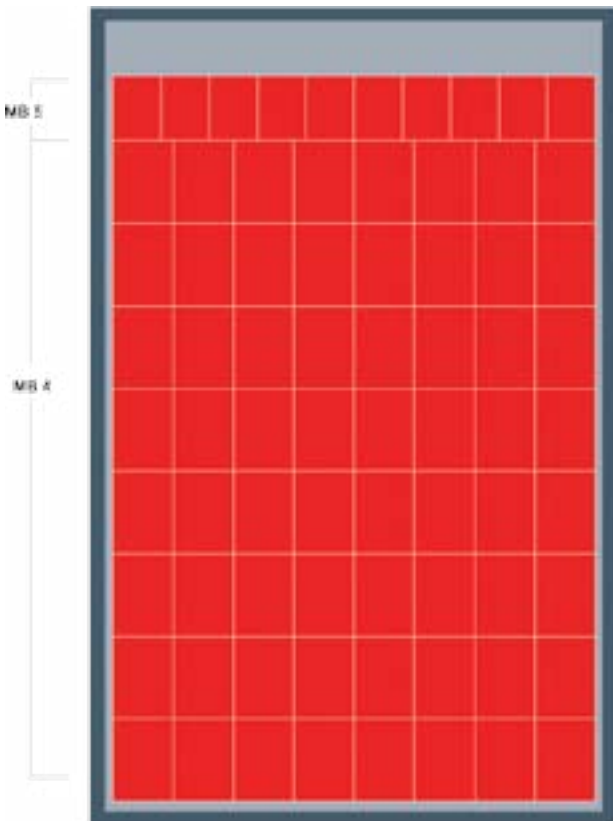

Fondo / Fund

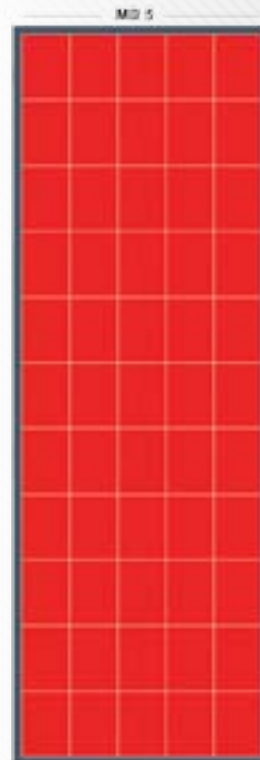

Pannelli / Panels

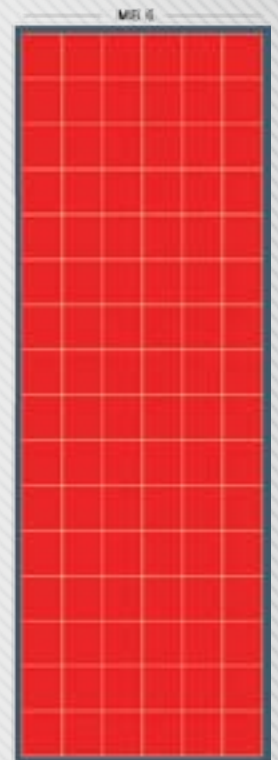

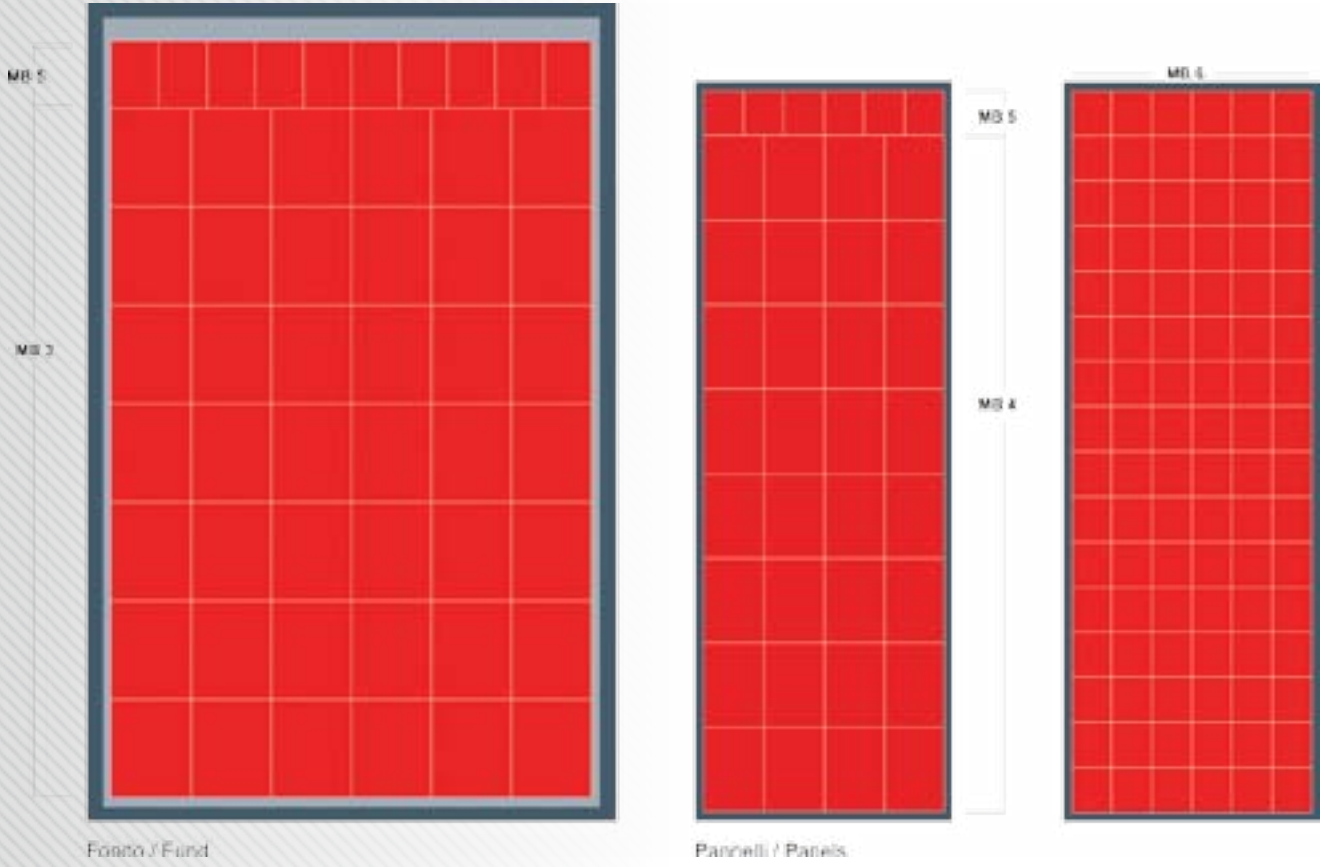

A

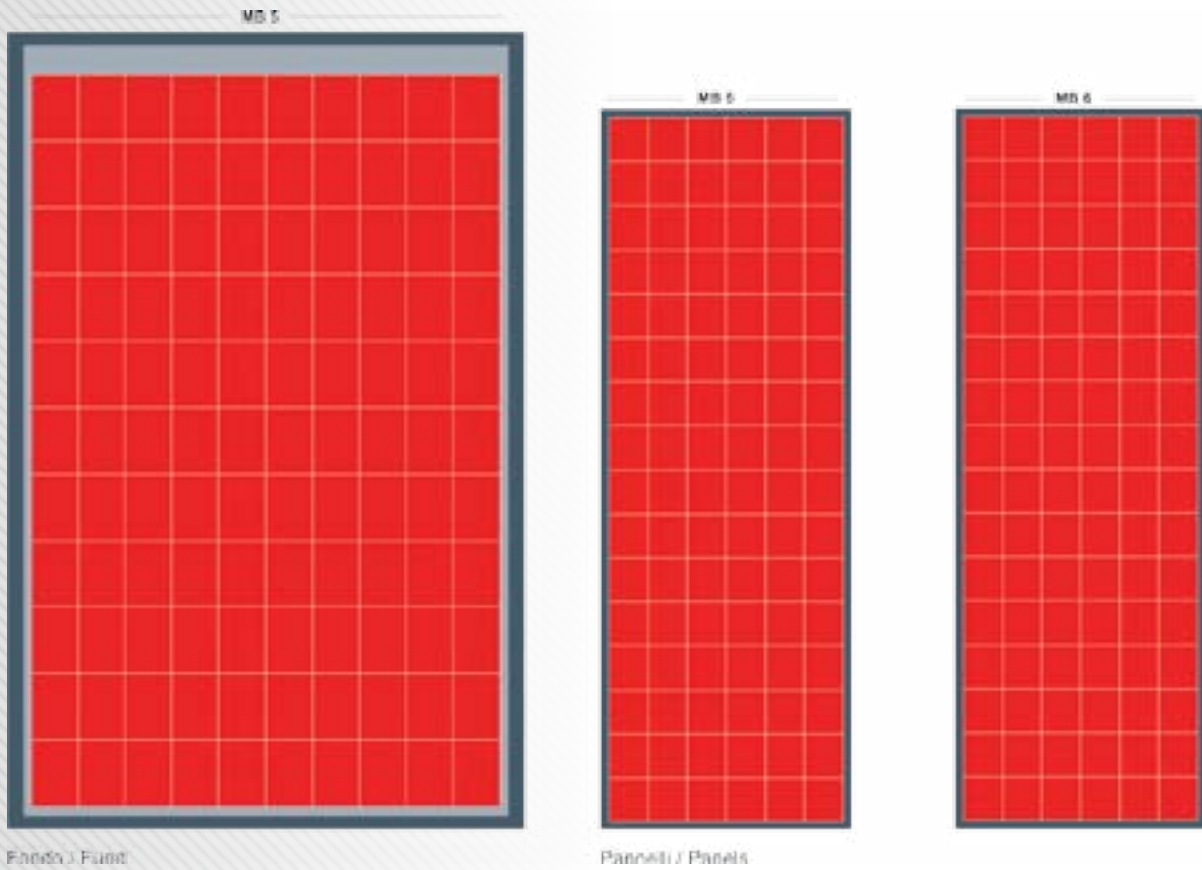

PRODUZIONE DI COMPONENTI IN PLASTICA E METALLO PER IL MAGAZZINAGGIO

B



					
Imballo Pz. Packages pcs.	1				
Dimensioni Dimensions	H 1965 mm - P 605 mm - L 1270 mm				
Portata singolo pannello Capacity of each panel	150 Kg.				
Fornito smontato / Supplied disassembled					
Dotazioni / Equipments					
	Fondo/Fund	Panel 1	Panel 2	Panel 3	Tot*
STANDARD	MB 5: 2	MB 6: 16	MB 6: 16	MB 6: 16	398
A	MB 6: 32	MB 6: 16	MB 6: 16	MB 6: 16	480
B	MB 4: 16 MB 5: 2	MB 6: 16	MB 6: 16	MB 6: 16	362
*Tot: Numero totale di cassetti / Total number of drawers					

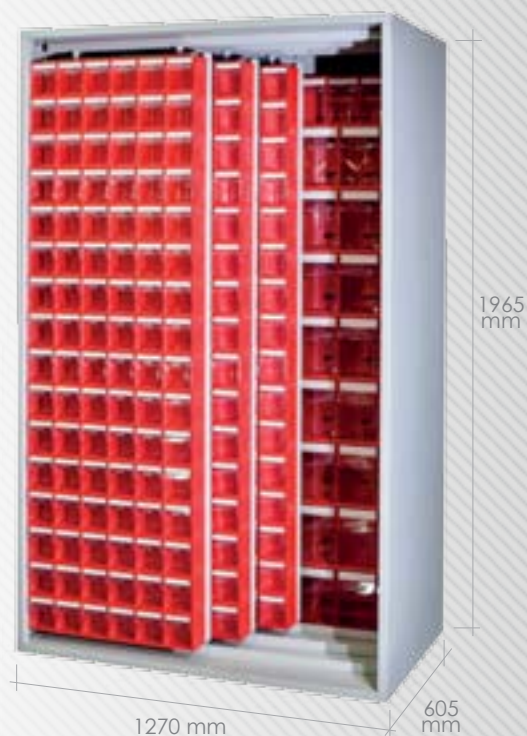

Standard

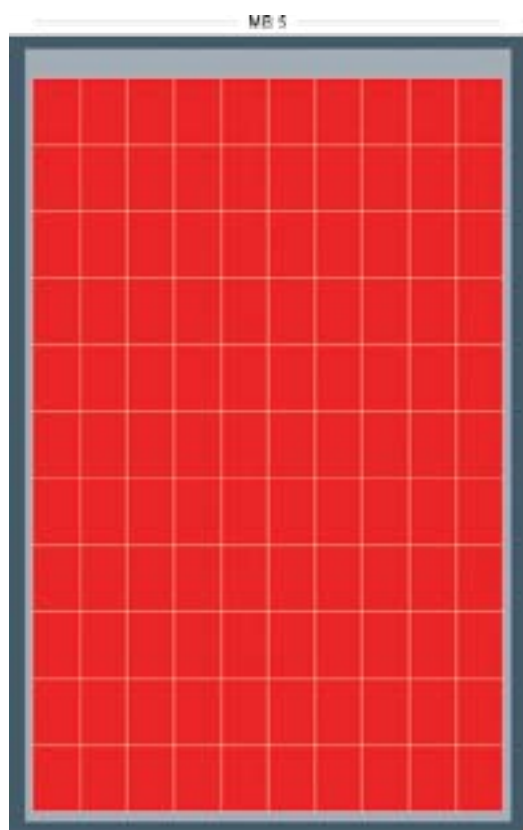

Fondo / Fund



Pannelli / Panels

A

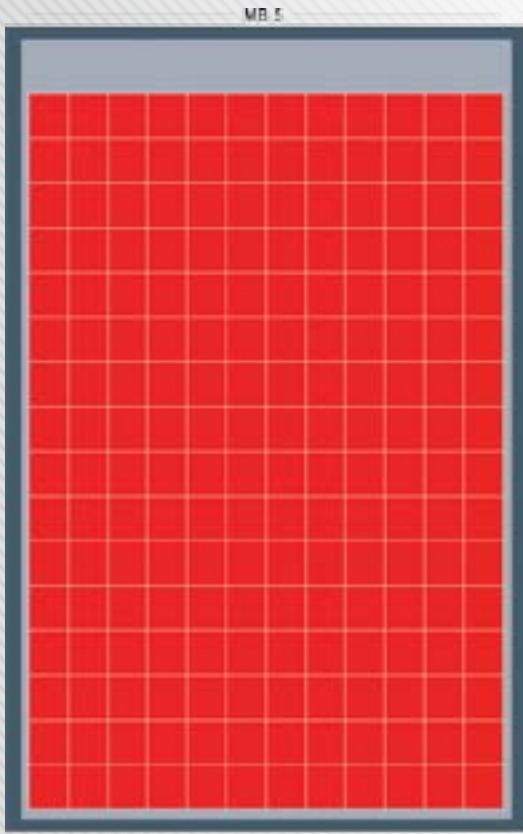

Fondo / Front

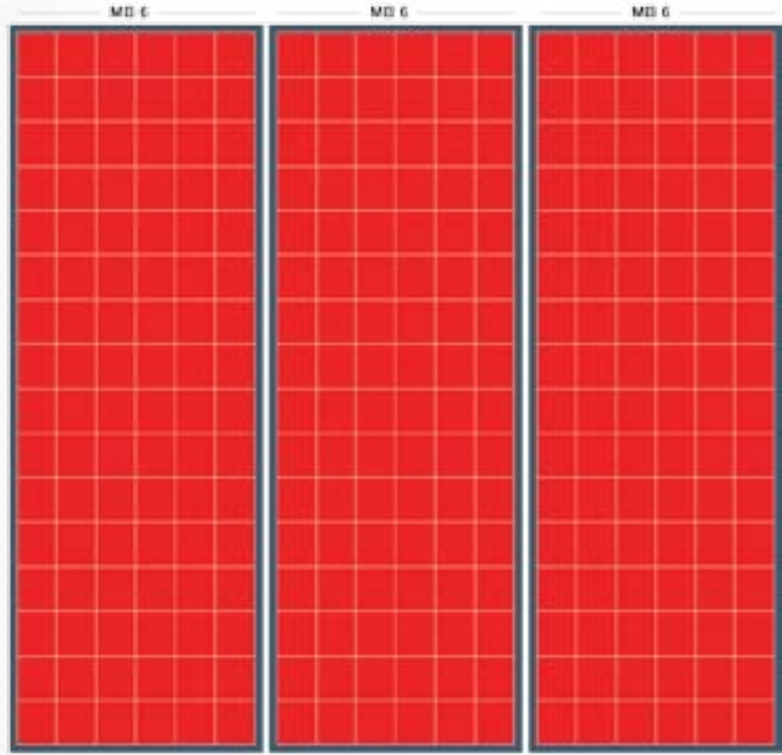

Pannelli / Panels

PRODUZIONE DI COMPONENTI IN PLASTICA E METALLO PER IL MAGAZZINAGGIO

B

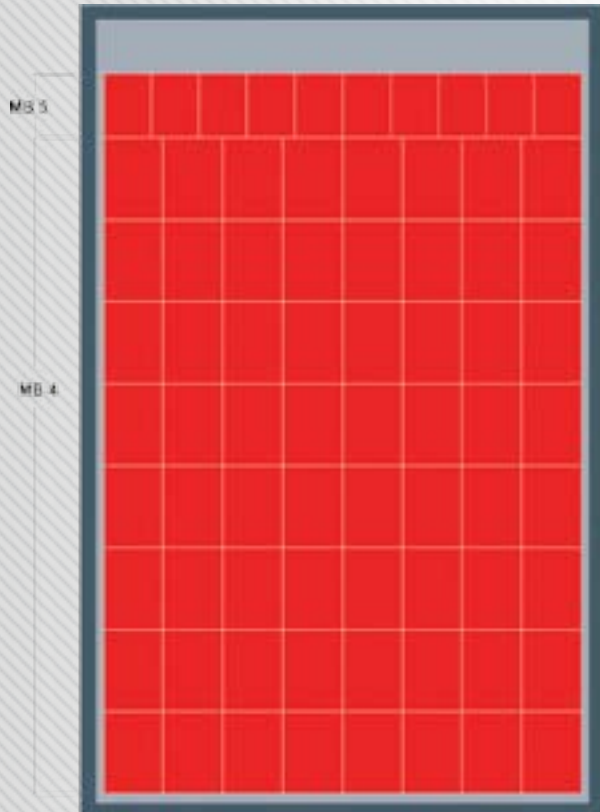

Fondo / Front



Pannelli / Panels

trolley CM 135



Imballo Pz. Packages pcs.	1	
Dimensioni Dimensions	H 1375 mm - P 605 mm - L 640 mm	
Accessori Accessories	Disponibile vuoto o con kit MULTIBOX	Available empty or with MULTIBOX kit
Colore / Color	RAL 7035	
Kit KEY BOX a richiesta / on demande KEY BOX kit		
Kit Standard	MB 9: n. 2 MB 6: n. 4 MB 5: n. 6 MB 4: n. 2	

**STEEL
PLASTIC**

trolley CM 165



Imballo Pz. Packages pcs.	1	
Dimensioni Dimensions	H 1675 mm - P 605 mm - L 640 mm	
Accessori Accessories	Disponibile vuoto o con kit MULTIBOX	Available empty or with MULTIBOX kit
Colore / Color	RAL 7035	
Kit KEY BOX a richiesta / on demande KEY BOX kit		
Kit Standard	MB 9: n. 4 MB 6: n. 6 MB 5: n. 4 MB 4: n. 4	

CONTENTORI / boxes

EURO BOX

ARMADI / cabinets

MULTISISTEM

TOOLBOX



TOOL BOX

48



Organizer e portautensili realizzati in polipropilene, utili per riporre utensili e minuteria per un facile pronto impiego sia professionale che hobbistico.



Organizer and toolboxes made of polypropylene; recommended for tools, nuts and bolts, suitable for professional use and DIY.

VALIGETTE / cases

53



Valigette di servizio polifunzionali robuste e di versatile impiego, particolarmente adatte alla dotazione degli autoveicoli officina mobile che realizzano assistenza riparazione e manutenzione in loco ove necessita.

Praticità e robustezza rendono questo prodotto un efficace strumento di lavoro per montatori, riparatori, tecnici ed installatori.

Le valigette **TEKNOBOX** sono realizzate in ABS, resina di particolare robustezza e prestigio estetico.

Grande novità il sistema di impilaggio: appoggiando una valigetta sull'altra con l'impiego di una sola mano, l'impilaggio avviene automaticamente grazie ai ganci laterali provvisti di molle.

La maniglia rientra a pressione della sede del coperchio.

TOP e **ULTRA** sono realizzate in alluminio, **LITE** e **MOVY** hanno una struttura in ABS termoformato con rinforzi in alluminio.

I modelli **LITE** e **MOVY** oltre alle due chiusure a chiave, dispongono di una ulteriore chiusura a combinazione.



Multi-purpose, strong and versatile cases; highly suitable for workshop-cars that carry out service, repair and maintenance on site.

This handy and strong product is an efficient working tool for installers, repair and installation technicians.

The **TEKNOBOX** cases are made of ABS shockproof.

The great news is the stacking system: place top-case on bottom-case and it locks automatically case to case, thanks to the 2 spring-loaded snap-lock; only one hand is needed. Four feet on the bottom of the case are designed conically to guide top-case easily in the right position.

TOP and **ULTRA** models are made of aluminium, **LITE** and **MOVY** have a very strong and nice-looking thermoformed ABS frame with aluminium reinforcement elements.

The **MOVY** and **LITE** models feature not only the key lock but also a combination lock.

TB 101

		
	Organizer con separatori estraibili	Organizer with removable divisors
Imballo / Package	20	
Dimensioni / Dimensions	H 35 mm - P 125 mm - L 230 mm	
Colore / Color	Trasparente	Transparent



TB 102



		
	Organizer con separatori estraibili	Organizer with removable divisors
Imballo / Package	20	
Dimensioni / Dimensions	H 42 mm - P 186 mm - L 292 mm	
colore / Color	Trasparente	Transparent

TB 103

		
	Organizer con separatori estraibili	Organizer with removable divisors
Imballo / Package	10	
Dimensioni / Dimensions	H 48 mm - P 234 mm - L 382 mm	
Colore / Color	Trasparente	Transparent



TB 106



		
	Organizer con compartimenti fissi	Organizer with fixed compartments
Imballo / Package	20	
Dimensioni / Dimensions	H 62 mm - P 180 mm - L 243 mm	
Colore / Color	Nero	Black

CONTENITORI / boxes

EURO BOX

ARMADI / cabinets

MULTISISTEM

TOOLBOX

TB 107



	Organizer con scomparti fissi	Organizer with fixed compartments
Imballo / Package	10	
Dimensioni / Dimensions	H 53 mm - P 250 mm - L 330 mm	
Colore / Color	Nero	Black

TB 108

	Organizer con separatori estraibili	Organizer with removable divisors
Imballo / Package	8	
Dimensioni / Dimensions	H 62 mm - P 305 mm - L 400 mm	
Colore / Color	Nero	Black



TB 109



	Organizer con vaschette	Organizer with cups
Imballo / Package	8	
Dimensioni / Dimensions	H 65 mm - P 325 mm - L 510 mm	
Colore / Color	Nero	Black

TB 110

	Portautensili	Toolbox
Imballo / Package	5	
Dimensioni / Dimensions	H 60 mm - P 350 mm - L 420 mm	
Colore / Color	Nero	Black



TB 120

		
	Portautensili	Toolbox
Imballo / Package	15	
Dimensioni / Dimensions	H 145 mm - P 150 mm - L 335 mm	
Colore / Color	Nero	Black





TB 121



		
	Portautensili	Toolbox
Imballo / Package	6	
Dimensioni / Dimensions	H 200 mm - P 215 mm - L 415 mm	
colore / Color	Nero	Black

TB 122

		
	Portautensili	Toolbox
Imballo / Package	2	
Dimensioni / Dimensions	H 270 mm - P 290 mm - L 520 mm	
Colore / Color	Nero	Black



TB 123

		
	Portautensili	Toolbox
Imballo / Package	2	
Dimensioni / Dimensions	H 285 mm - P 300 mm - L 590 mm	
Colore / Color	Nero	Black

CONTENITORI / boxes

EURO BOX

ARMADI / cabinets

MULTISISTEM

TOOLBOX

TB 124



		
	Portautensili	Toolbox
Imballo / Package	10	
Dimensioni / Dimensions	H 130 mm - P 285 mm - L 375 mm	
Colore / Color	Nero	Black

TB 125

		
	Sgabello	Stool
Imballo / Package	2	
Dimensioni / Dimensions	H 300 mm - P 300 mm - L 470 mm	
Colore / Color	Nero	Black



TEKNOBOX



Portautensili professionale in ABS / Professional ABS toolbox			
	BOX 1	BOX 2	BOX 3
Imballo / Package	3	2	1
Altezza / Height	142 mm	212 mm	362 mm
Profondità / Depth	335 mm		
Larghezza / Width	464 mm		
Colore / Color	Nero / Black		
Accessori a richiesta On demande accessories	Vaschette (rosse o nere) / Cups (red or black) Carrello / Trolley		

Box 1

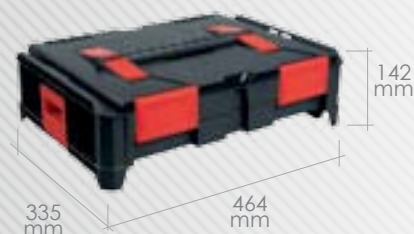

Box 2



Box 3



Vaschette / Cups

(a richiesta / on demande)



L5



L6



L7

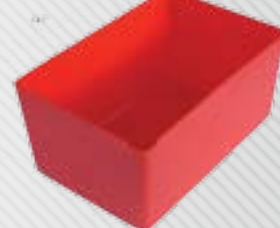

L8



CONTENITORI / boxes

EURO BOX

ARMADI / cabinets

MULTISISTEM

TOOLBOX

TOP



		
Imballo / Package	1	
Dimensioni / Dimensions	H 210 mm - P 420 mm - L 510 mm	
Colore / Color	Argento	Silver

ULTRA

		
Imballo / Package	1	
Dimensioni / Dimensions	H 200 mm - P 380 mm - L 480 mm	
Colore / Color	Argento	Silver



LITE

		
Imballo / Package	1	
Dimensioni / Dimensions	H 190 mm - P 370 mm - L 480 mm	
Colore / Color	Nero	Black

MOVY

		
Imballo / Package	1	
Dimensioni / Dimensions	H 270 mm - P 430 mm - L 510 mm	
Colore / Color	Nero	Black



Note:

A large white rectangular area with horizontal ruling lines, intended for writing a note. The lines are evenly spaced and extend across the width of the area. The area is set against a background with a fine, repeating pattern of small, light-colored shapes.

Note:

A large white rectangular area with horizontal ruling lines, intended for writing a note. The lines are evenly spaced and extend across the width of the page.

STEEL PLASTIC[®]

S.r.l.



*Feel
the difference!*



KEYBOX
FOR EVERYTHING



Your visible value!



MULTIBOX
PURPOSE

Realizzazione catalogo a cura di:

ForNext di Davide Castellani

<http://www.fornext.it>

Stampato da:

La Grafica

<http://www.lagrafica.net/>

KEYBOX

STEEL®
PLASTIC S.r.l.

www.steelplastic.it
info@steelplastic.it

